

SMAKSAK





ENGLISH

For the IKEA appointed Authorized Service Centre, please refer to www.IKEA.com and select your local store for phone numbers and opening times.

ENGLISH

4

Contents

Safety information	4	Additional functions	17
Safety instructions	7	Hints and tips	18
Installation	10	Care and cleaning	25
Product description	10	Troubleshooting	26
Control panel	11	Technical data	28
Before first use	11	Environmental concerns	28
Daily use	12	IKEA GUARANTEE	30
Clock functions	14		
Using the accessories	16		

Subject to change without notice.

 **Safety information**

Before the installation and use of the appliance, carefully read the supplied instructions. The manufacturer is not responsible if an incorrect installation and use causes injuries and damage. Always keep the instructions with the appliance for future reference.

Children and vulnerable people safety

- This appliance can be used by children aged from 8 years and above and persons with reduced physical, sensory or mental capabilities or lack of experience and knowledge if they have been given supervision or instruction concerning the use of the appliance in a safe way and understand the hazards involved. Children of less than 8 years of age and persons with very extensive and complex disabilities shall be kept away from the appliance unless continuously supervised.
- Children should be supervised to ensure that they do not play with the appliance.
- Keep all packaging away from children and dispose of it appropriately.

- **WARNING:** Keep children and pets away from the appliance when it operates or when it cools down. Accessible parts become hot during use.
- If the appliance has a child safety device, it should be activated.
- Children shall not carry out cleaning and user maintenance of the appliance without supervision.

General Safety

- Only a qualified person must install this appliance and replace the cable.
- **WARNING:** The appliance and its accessible parts become hot during use. Care should be taken to avoid touching heating elements.
- Always use oven gloves to remove or put in accessories or ovenware.
- Before any maintenance, cut the power supply.
- **WARNING:** Ensure that the appliance is switched off before replacing the lamp to avoid the possibility of electric shock.
- Do not use the appliance before installing it in the built-in structure.
- Do not use a steam cleaner to clean the appliance.
- Do not use harsh abrasive cleaners or sharp metal scrapers to clean the glass door since they can scratch the surface, which may result in shattering of the glass.
- If the mains power supply cable is damaged, it must be replaced by the manufacturer, its Authorised Service Centre or similarly qualified persons to avoid an electrical hazard.
- Do not activate the appliance when it is empty. Metal parts inside the cavity can create electric arcing.
- To remove the shelf supports first pull the front of the shelf support and then the rear end away from the side walls. Install the shelf supports in the opposite sequence.

- If the door or door seals are damaged, the appliance must not be operated until it has been repaired by a competent person.
- Only a qualified person can carry out any service or repair operation that involves the removal of a cover which gives protection against exposure to microwave energy.
- Do not heat liquids and other foods in sealed containers. They are liable to explode.
- Metallic containers for food and beverages are not allowed during microwave cooking. This requirement is not applicable if the manufacturer specifies size and shape of metallic containers suitable for microwave cooking.
- Use only utensils that are suitable for use in microwave ovens.
- When heating food in plastic or paper containers, keep an eye on the appliance due to the possibility of ignition.
- The appliance is intended for heating food and beverages. Drying of food or clothing and heating of warming pads, slippers, sponges, damp cloth and similar may lead to risk of injury, ignition or fire.
- If smoke is emitted, switch off or unplug the appliance and keep the door closed in order to stifle any flames.
- Microwave heating of beverages can result in delayed eruptive boiling. Care must be taken when handling the container.
- The contents of feeding bottles and baby food jars shall be stirred or shaken and the temperature checked before consumption, in order to avoid burns.
- Eggs in their shell and whole hard-boiled eggs should not be heated in the appliance since they may explode, even after microwave heating has ended.
- The appliance should be cleaned regularly and any food deposits removed.

- Failure to maintain the appliance in a clean condition could lead to deterioration of the surface that could adversely affect the life of the appliance and possibly result in a hazardous situation.

Safety instructions

Installation

⚠ Warning! Only a qualified person must install this appliance.

- Remove all the packaging.
- Do not install or use a damaged appliance.
- Follow the installation instructions supplied with the appliance.
- Always take care when moving the appliance as it is heavy. Always use safety gloves and enclosed footwear.
- Do not pull the appliance by the handle.
- Install the appliance in a safe and suitable place that meets installation requirements.
- Keep the minimum distance from other appliances and units.
- Before mounting the appliance, check if the oven door opens without restraint.

Depth of the appliance	567 mm
Built in depth of the appliance	546 mm
Depth with open door	882 mm
Ventilation opening minimum size. Opening placed on the bottom rear side	560x20 mm
Mains supply cable length. Cable is placed in the right corner of the back side	1500 mm
Mounting screws	3.5x25 mm

Cabinet minimum height (Cabinet under the worktop minimum height)	444 (460) mm
Cabinet width	560 mm
Cabinet depth	550 (550) mm
Height of the front of the appliance	455 mm
Height of the back of the appliance	440 mm
Width of the front of the appliance	595 mm
Width of the back of the appliance	559 mm

Electrical connection

⚠ Warning! Risk of fire and electric shock.

- All electrical connections should be made by a qualified electrician.
- The appliance must be earthed.
- Make sure that the parameters on the rating plate are compatible with the electrical ratings of the mains power supply.
- Always use a correctly installed shockproof socket.
- Do not use multi-plug adapters and extension cables.
- Make sure not to cause damage to the mains plug and to the mains cable. Should the mains cable need to be

replaced, this must be carried out by our Authorised Service Centre.

- Do not let mains cables touch or come near the appliance door or the niche below the appliance, especially when it operates or the door is hot.
- The shock protection of live and insulated parts must be fastened in such a way that it cannot be removed without tools.
- Connect the mains plug to the mains socket only at the end of the installation. Make sure that there is access to the mains plug after the installation.
- If the mains socket is loose, do not connect the mains plug.
- Do not pull the mains cable to disconnect the appliance. Always pull the mains plug.
- Use only correct isolation devices: line protecting cut-outs, fuses (screw type fuses removed from the holder), earth leakage trips and contactors.
- The electrical installation must have an isolation device which lets you disconnect the appliance from the mains at all poles. The isolation device must have a contact opening width of minimum 3 mm. For Taiwan only: isolation devices must be verified and registered by the Bureau of Standards, Metrology and Inspection of the Ministry of Economic Affairs.

Use

 **Warning!** Risk of injury, burns and electric shock or explosion.

- This appliance is for household (indoors) use only.
 - Do not change the specification of this appliance.
 - Make sure that the ventilation openings are not blocked.
 - Do not let the appliance stay unattended during operation.
 - Deactivate the appliance after each use.
 - Be careful when you open the appliance door while the appliance is in operation. Hot air can release.
 - Do not operate the appliance with wet hands or when it has contact with water.
 - Do not apply pressure on the open door.
 - Do not use the appliance as a work surface or as a storage surface.
 - Open the appliance door carefully. The use of ingredients with alcohol can cause a mixture of alcohol and air.
 - Do not let sparks or open flames to come in contact with the appliance when you open the door.
 - Do not put flammable products or items that are wet with flammable products in, near or on the appliance.
 - Do not use microwave function to preheat the oven.
-  **Warning!** Risk of damage to the appliance.
- To prevent damage or discoloration to the enamel:
 - do not put aluminium foil directly on the bottom of cavity of the appliance.
 - do not put water directly into the hot appliance.
 - do not keep moist dishes and food in the appliance after you finish the cooking.
 - be careful when you remove or install the accessories.
 - Discoloration of the enamel or stainless steel has no effect on the performance of the appliance.
 - Use a deep pan for moist cakes. Fruit juices cause stains that can be permanent.
 - This appliance is for cooking purposes only. It must not be used for other purposes, for example room heating.
 - Always cook with the oven door closed.
 - If the appliance is installed behind a furniture panel (e.g. a door) make sure the door is never closed when the appliance operates. Heat and moisture can build up behind a closed furniture panel and cause subsequent damage to the appliance, the housing unit or the floor. Do not close the furniture panel until the appliance has cooled down completely after use.

Care and Cleaning

⚠ Warning! Risk of injury, fire, or damage to the appliance.

- Before maintenance, deactivate the appliance and disconnect the mains plug from the mains socket.
- Make sure the appliance is cold. There is a risk that the glass panels can break.
- Replace immediately the door glass panels when they are damaged. Contact the Authorised Service Centre.
- Make sure the cavity and the door are wiped dry after each use. Steam produced during the operation of the appliance condensates on cavity walls and can cause corrosion.
- Clean regularly the appliance to prevent the deterioration of the surface material.
- Fat and food remaining in the appliance can cause fire and electric arcing when the microwave function operates.
- If you use an oven spray, obey the safety instructions on the packaging.
- Do not remove the knobs from the appliance.

Glassware use

Handling your glassware without an appropriate degree of care could result in breakage, chipping, cracking or severe scratching:

- Do not spill cold water or other liquids on the glassware because a sudden temperature drop may cause immediate breakage of the glass. Broken glass pieces may be extremely sharp and difficult to locate.
- Do not place hot glassware on a wet or cool surface, directly on countertop or metal surface, or in sink; or handle hot glassware with wet cloth.
- Do not use or repair any glassware that is chipped, cracked or severely scratched.
- Do not drop or hit glassware against a hard object or strike utensils against it.
- Do not heat empty or nearly empty glassware in microwave, or overheat oil

or butter in microwave (use minimum amount of cooking time).

Allow hot glassware to cool on a cooling rack, a potholder or a dry cloth. Make sure that the glassware is cool enough before washing, refrigerating or freezing.

Avoid handling hot glassware (including ware with silicone gripping surfaces) without dry potholders.

Avoid microwave misuse (i.e. running the oven without any load or small load).

Internal lighting

⚠ Warning! Risk of electric shock.

- Concerning the lamp(s) inside this product and spare part lamps sold separately: These lamps are intended to withstand extreme physical conditions in household appliances, such as temperature, vibration, humidity, or are intended to signal information about the operational status of the appliance. They are not intended to be used in other applications and are not suitable for household room illumination.
- Use only lamps with the same specifications.

Service

- To repair the appliance contact the Authorised Service Centre.
- Use original spare parts only.

Disposal

⚠ Warning! Risk of injury or suffocation.

- Disconnect the appliance from the mains supply.
- Cut off the mains electrical cable close to the appliance and dispose of it.
- Remove the door to prevent children and pets to get closed in the appliance.
- **Packaging material:** The packaging material is recyclable. Plastic parts are marked with international abbreviations such as PE,

PS, etc. Dispose of the packaging material in the containers provided for this

purpose at your local waste management facility.

Installation

Warning! Refer to Safety chapters.

Assembly

i Refer to the Assembly Instructions for the installation.

Electrical installation

Warning! Only a qualified person must do the electrical installation.

i The manufacturer is not responsible if you do not follow the safety precautions from the Safety chapters.

This oven is only supplied with a main cable.

Cable

Cable types applicable for installation or replacement:

H07 RN-F, H05 RN-F, H05 RRF, H05 VV-F, H05 V2V2-F (T90), H05 BB-F

For the section of the cable refer to the total power on the rating plate. You can also refer to the table:

Total power (W)	Section of the cable (mm ²)
maximum 1380	3 x 0.75
maximum 2300	3 x 1
maximum 3680	3 x 1.5

The earth cord (green / yellow cable) must be 2 cm longer than phase and neutral cables (blue and brown cables).

Product description

General overview

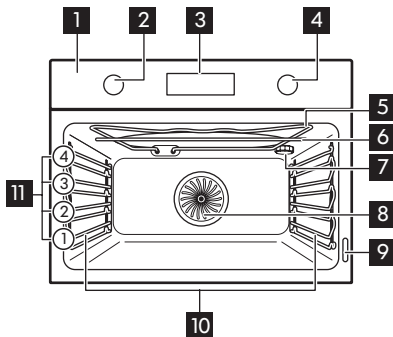

- 1** Control panel
- 2** Knob for the heating functions
- 3** Display
- 4** Control knob
- 5** Heating element
- 6** Microwave generator
- 7** Lamp
- 8** Fan
- 9** Rating plate
- 10** Shelf support, removable
- 11** Shelf positions

Accessories

- **Wire shelf** x 1
For cookware, cake tins, roasts.
- **Baking tray** x 1

For cakes and biscuits.

- **Microwave bottom glass plate** x 1
To support microwave mode.

Control panel

Buttons

Sensor field / Button	Function	Description
	OPTIONS	To set the clock functions, microwave power. To check the oven temperature. Use only while a heating function operates.
	START + 30sec	To start a heating function. Press to extend Microwave function duration for 30 seconds.
	OK	To confirm.

Display

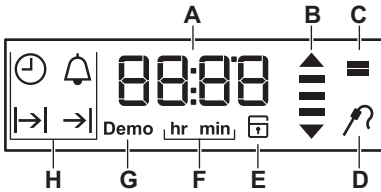

- A.** Timer / Temperature / Microwave power
- B.** Heat-up and residual heat indicator
- C.** Microwave mode
- D.** Core temperature sensor (selected models only)
- E.** Door lock (selected models only)
- F.** Hours / minutes
- G.** Demo mode (selected models only)
- H.** Clock functions

Before first use

- Warning!** Refer to Safety chapters.
- To set the Time of day refer to "Clock functions" chapter.

- Refer to "Care and cleaning" chapter.

Clean the oven and the accessories before first use.
Put the accessories and the removable shelf supports back to their initial position.



Initial Cleaning

Remove all accessories and removable shelf supports from the oven.

Preheating

Before first use preheat the oven with only wire shelf and baking tray inside. The

microwave bottom glass plate must be removed.

1. Set the function . Set the maximum temperature.
2. Let the oven operate for 1 hour.
3. Set the function . Set the maximum temperature.
4. Let the oven operate for 15 minutes.
5. Turn off the oven and let it cool down. Accessories can become hotter than usual. The oven can emit an odour and smoke. Make sure that the airflow in the room is sufficient.

Using the Mechanical child lock

The oven has the child lock installed. It is on the right side of the oven, below the control panel.

To open the oven door with the child lock:

1. Pull and hold the child lock handle up as shown in the picture.

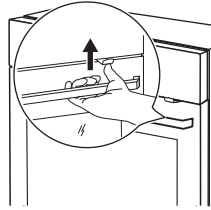

2. Open the door. Close the oven door without pulling the child lock.

To remove the child lock, open the oven door and remove the child lock with the torx key. The torx key is in the oven fitting bag.



Screw back the screw into the hole after removing the child lock.



 **Warning!** Be careful not to scratch the control panel.







Daily use

 **Warning!** Refer to Safety chapters.

Heating functions

Heating function	Application
 Off position	The oven is off.
 Forced Air Cooking	To bake on up to two shelf positions at the same time and to dry food. Set the temperature 20 - 40 °C lower than for Conventional (Top and Bottom Heat).

Heating function	Application
 Conventional (Top and Bottom Heat)	To bake and roast food on one shelf position.
 Grilling	To grill food in medium quantities in the middle of the shelf. To make toasts.
 True Fan Cooking + MW	Microwave Combi - function with MW boost that accelerates cooking. To bake on one shelf position. Do not preheat the oven.

Heating function	Application
 Conventional Cooking + MW	Microwave Combi - function with MW boost that accelerates cooking. To bake and roast food on one shelf position. Do not preheat the oven.
 Grill + MW	Microwave Combi - function with MW boost that accelerates cooking. To grill flat food and to toast bread. Do not preheat the oven.
 Microwave	Microwave function (100 - 1000 W). Creates the heat directly in the food. To heat pre-prepared meals and drinks, to defrost meat or fruit, and to cook vegetables and fish. Do not preheat the oven.
 Liquids	Microwave function at high power (800 - 1000 W). To heat drinks. Creates the heat directly in the food. Do not preheat the oven.
 Defrost	Microwave function at low power (100 - 200 W). To defrost meat, fish, bread, fruit and vegetables. Creates the heat directly in the food. Do not preheat the oven.
 Reheating	Microwave function at medium power (300 - 700 W). To heat pre-prepared meals. Creates the heat directly in the food. Do not preheat the oven.

⚠ Caution! Use microwave glass bottom plate only with Microwave function.
 Do not use microwave glass bottom plate with Microwave Combi function.

Setting a heating function

1. Remove microwave bottom glass plate.
2. Turn the knob for the heating functions to select a heating function.
3. Turn the control knob to select the temperature. Press \triangleright_{+30} to confirm. The lamp turns on when the oven operates.
4. To turn off the oven, turn the knobs to the off position.

Turn the control knob to change the temperature during cooking. Turn the knob for the heating function to change a heating function during cooking and press \triangleright_{+30} to confirm.

Setting microwave function

1. Remove all accessories.
2. Insert microwave bottom glass plate.
3. Turn the knob for the heating functions to select the function: .

⚠ Caution! Do not let the oven operate when there is no food in it.

Press \triangleright_{+30} to start with the default settings.



4. Press  again and again to switch between the settings for: Duration and microwave power. Turn the control knob to set the value and press OK to confirm. You can also press \triangleright_{+30} to change Duration in 30 seconds steps.

When the time set for Duration ends, the signal sounds and the oven stops.

5. Turn the knob for the heating functions to the off position to turn off the oven.



When you open the oven door, the oven stops. To start it again, close the door and press \triangleright_{+30} .

Setting function: Microwave Combi

1. Remove microwave bottom glass plate.
2. Turn the knob for the heating functions to select the function   .

 **Caution!** Do not let the oven operate when there is no food in it.

The display shows the default temperature.

3. Press  ₊₃₀ to start.
4. Press  again and again to change: Duration, microwave power, temperature. Turn the control knob to set the value and press **OK** to confirm. Around 5 degrees before the set temperature is reached the signal sounds. When the set time ends the signal sounds again and the oven stops.

5. Turn the knob for the heating functions to the off position. When you use this function with the time set for more than 7 minutes, the microwave power cannot be more than 600 W.





 The oven can make noises when using the function: Microwave Combi. They are normal for this function.

Heat-up indicator

When the oven function operates, the bars in the display  appear one by one when the temperature in the oven increases, and disappear when it decreases.

Clock functions

Clock functions table

Clock function	Application
 TIME OF DAY	To show or change the time of day. You can change the time of day only when the oven is off.
 DURATION	To set how long the oven works. Use only when a heating function is set.
 END	To set when the oven turns off. Use only when a heating function is set.
 TIME DELAY	Combination of DURATION and END function.
 MINUTE MINDER	Use to set a countdown time. This function has no effect on the operation of the oven. You can set the MINUTE MINDER at any time, also if the oven is off.

Clock function	Application
00:00 COUNT UP TIMER	If you do not set any other clock function the COUNT UP TIMER automatically monitor how long the oven works. The counting starts immediately when the oven starts to heat. The Count Up Timer cannot be used with the functions: DURATION, END.

Setting and changing the time

After the first connection to the mains, wait until the display shows **hr** and "12:00". "12" flashes.

1. Turn the control knob to set the hours.
2. Press  to confirm and set the minutes. The display shows **min** and the set hour. "00" flashes.
3. Turn the control knob to set the current minutes.

4. Press **OK** to confirm or the set time of day will be saved automatically after 5 seconds.

The display shows the new time.

To change the time of day press **↵** again and again until the indicator for the time of day **⌚** flashes in the display.

Setting the DURATION function

1. Set a heating function. Press **▷4:30** to confirm.
2. Press **↵** again and again until **|→|** starts to flash.
3. Turn the control knob to set the minutes and press **↵** to confirm. Turn the control knob to set the hours and press **OK** to confirm.

When the set Duration time ends the signal sounds for 2 minutes. **|→|** and time setting flash in the display. The oven turns off automatically.

4. Press any button or open the oven door to stop the signal.
5. Turn the knobs to the off position. This function is not available for some oven functions.

Setting the END function

1. Set a heating function. Press **▷4:30** to confirm.
2. Press **↵** again and again until **→|** starts to flash.
3. Turn the control knob to set the hours and press **↵** to confirm. Turn the control knob to set the minutes and press **OK** to confirm.

At the set End time the signal sounds for 2 minutes. **→|** and time setting flash in the display. The oven turns off automatically.

4. Press any button or open the oven door to stop the signal.

This function is not available for some oven functions.

Setting the TIME DELAY function

1. Set a heating function. Press **▷4:30** to confirm.
2. Press **↵** again and again until **|→|** starts to flash.
3. Turn the control knob to set the minutes for DURATION time and press **↵** to confirm. Turn the control knob to set the hours for DURATION time and press **↵** to confirm.

The display shows flashing **→|**.

4. Turn the control knob to set the hours for END time and press **↵** to confirm. Turn the control knob to set the minutes for END time and press **↵** to confirm. The display shows **|→|→|** and the set temperature.

Oven turns on automatically later on, works for the set DURATION time and stops at the set END time.

At the set END time the signal sounds for 2 minutes. **→|** and time setting flash in the display. The oven turns off.

5. Press any button or open the oven door to stop the signal.
6. Turn the knobs to the off position. You can change the heating function and the temperature after you set the TIME DELAY function.

Turn the knobs to the off positions to stop the TIME DELAY function.

Setting the MINUTE MINDER

Minute minder can be both set when the oven is turned on and off.

1. Press **↵** again and again until **🔔** starts to flash.
2. Turn the control knob to set the seconds and then the minutes.
 - Press **↵** one more time to set the minutes
 - Press **↵** two more times to set the hours
3. Press **↵** to confirm.

- 4. The MINUTE MINDER starts automatically after 5 seconds. After 90% of the set time the signal sounds.
- 5. When the set time ends the signal sounds for 2 minutes. "00:00" and  flash in the display. Press any button to stop the signal.

COUNT UP TIMER

Press  again and again until the display shows time without any symbols.

Using the accessories

 **Warning!** Refer to Safety chapters.

Inserting the accessories

Use only suitable cookware and material.

 **Warning!** Refer to "Hints and tips" chapter, Microwave suitable cookware and materials.

Wire shelf:

Push the shelf between the guide bars of the shelf support and make sure that the feet point down.

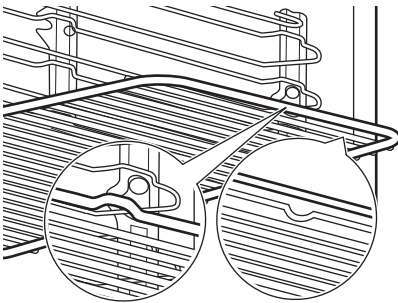

Baking tray:

Push the baking tray between the guide bars of the shelf support.

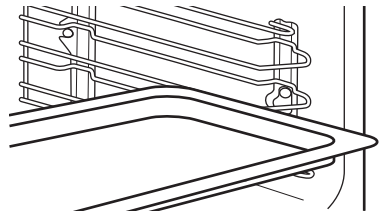

Wire shelf and baking tray together:

Push the baking tray between the guide bars of the shelf support and the wire shelf on the guide bars above.

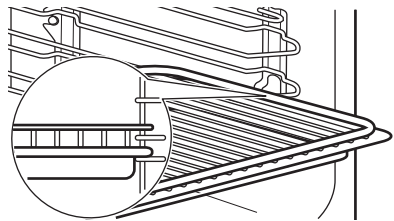

 Small indentation at the top increase safety. The indentations are also anti-tip devices. The high rim around the shelf prevents cookware from slipping of the shelf.

Microwave bottom glass plate:

 **Caution!** Use the microwave bottom glass plate only with microwave function. Remove the accessory when you switch to another function e.g. microwave grilling or grilling.

Put the accessory on the bottom of the cavity. Put the food on the microwave bottom glass plate.

Always use the microwave bottom glass plate when the microwave function is on. It is necessary for heating food or liquids.

Warning! The microwave bottom glass plate can become hot when the oven operates.

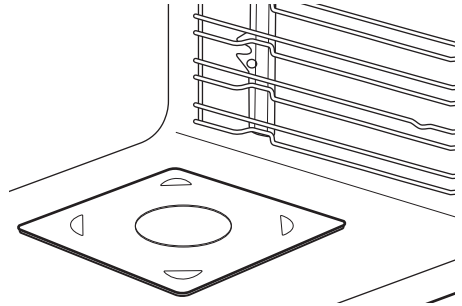

Additional functions

Using the Child Lock

When the Child Lock is on the oven cannot be turned on accidentally.

1. Ensure the knob for the oven functions is in the off position.
2. Press and hold Δ_{+30} and OK at the same time for 2 seconds.

The signal sounds. SAFE appears on the display.

To turn off the Child Lock, repeat step 2.

Residual heat indicator

When you turn off the oven, the display shows the residual heat indicator \equiv if the temperature in the oven is more than 40 °C. Turn the control knob left or right to check the oven temperature.

Automatic Switch-off

For safety reasons the oven turns off automatically after some time if a heating function operates and you do not change the oven temperature.

Temperature (°C)	Switch-off time (h)
120 - 195	8.5
200 - 230	5.5

After an automatic switch-off, press any button to operate the oven again.

i The Automatic switch-off does not work with the functions: Light, Duration, End.

Cooling fan

When the oven operates, the cooling fan turns on automatically to keep the surfaces of the oven cool. If you turn off the oven, the cooling fan can continue to operate until the oven cools down.

Safety thermostat

Incorrect operation of the oven or defective components can cause dangerous overheating. To prevent this, the oven has a safety thermostat which interrupts the power supply. The oven turns on again automatically when the temperature drops.

Temperature (°C)	Switch-off time (h)
30 - 115	12.5

Hints and tips

 **Warning!** Refer to Safety chapters.

Cooking recommendations

Use the function Forced Air Cooking to preheat the oven in the fastest way.

Whenever preheating, remove the wire shelves and trays from the cavity to have the fastest performance.

The oven has four shelf positions. Count the shelf positions from the bottom of the cavity.

The oven has a special system which circulates the air and constantly recycles the steam. With this system you can cook in a steamy environment and keep the food soft inside and crusty outside. It decreases the cooking time and energy consumption to a minimum.

Moisture can condense in the oven or on the door glass panels during cooking. Always stand back from the oven when you open the oven door.

When the oven cools down, clean the cavity with a soft cloth.

Baking cakes

Do not open the oven door before 3/4 of the set cooking time is up.

If you use two baking trays at the same time, keep one empty level between them.

Cooking meat and fish

Leave the meat for approximately 15 minutes before carving so that the juice does not seep out.

To prevent too much smoke in the oven during roasting, add some water into the deep pan. To prevent the smoke condensation, add water each time after it dries up.

Cooking times

Cooking times depend on the type of food, its consistency, and volume.

Initially, monitor the performance when you cook. Find the best settings (heat setting, cooking time, etc.) for your cookware, recipes and quantities when you use this appliance.

Microwave recommendations

Place the food on the microwave bottom glass plate on the bottom of the cavity.

Turn or stir the food halfway through the defrosting and cooking time.

Cover the food for cooking and reheating.

Put the spoon to the bottle or glass when heating drinks to ensure better heat distribution.

Put the food into the oven without any packaging. The packaged ready meals can be put into the oven only when the packaging is microwave safe (check information on the packaging).

Microwave cooking

Cook food covered. If you want to keep a crust cook food without a cover.

Do not overcook the dishes by setting the power and time too high. The food can dry out, burn or cause fire.

Do not use the oven to cook eggs or snails in their shells, because they can burst. Pierce the yolk of fried egg before reheating it.

Pierce food with skin or peel with a fork several times before cooking.

Cut vegetables into similar-sized pieces.

Stir liquid dishes from time to time.

Stir the food before serving.

After you turn off the oven, take the food out and let it stand for a few minutes.

Microwave defrosting

Put the frozen, unwrapped food on a small upturned plate with a container below it, or on a defrosting rack or plastic sieve so that the defrosting liquid can run off.

Remove defrosted pieces subsequently.

To cook fruit and vegetables without defrosting them first, you can use a higher microwave power.

Microwave suitable cookware and materials

For the microwave use only suitable cookware and materials. Use below table as a reference.

Cookware / Material	Microwave function		Microwave Combi function e.g. 
	Defrosting	Heating, Cooking	
Ovenproof glass and porcelain with no metal components, e.g. heat-proof glass	✓	✓	✓
Non-ovenproof glass and porcelain without any silver, gold, platinum or other metal decorations	✓	X	X
Glass and glass ceramic made of ovenproof / frost-proof material	✓	✓	✓
Ceramic and earthenware without any quartz or metal components and glazes which contain metal	✓	✓	X
Ceramic, porcelain and earthenware with unglazed bottom or with small holes, e.g. on handles	X	X	X
Heat-resistant plastic up to 200 °C (please always check the plastic container specification before use)	✓	✓	X
Cardboard, paper	✓	X	X
Clingfilm	✓	X	X
Roasting film with microwave safe closure (please always check the film specification before use)	✓	✓	X
Roasting dishes made of metal, e.g. enamel, cast iron	X	X	✓
Baking tins, black lacquer or silicon-coated (please always check the baking tins specification before use)	X	X	✓
Baking tray	X	X	X
Wire shelf	X	X	✓

Cookware / Material	Microwave function		Microwave Combi function e.g. 
	Defrosting	Heating, Cooking	
Microwave glass bottom plate	✓	✓	X
Cookware for microwave use, e.g. crisp pan	X	✓	X

Microwave defrosting

Food	Power (Watts)	Time (min)	Standing time (min)
Steak (0.2 kg)	100	5 - 7	5 - 10
Minced meat (0.5 kg)	200	8 - 12	5 - 10
Chicken (1 kg)	100	30 - 35	10 - 20
Chicken breast (0.15 kg)	100	5 - 9	10 - 15
Chicken legs (0.15 kg)	100	5 - 9	10 - 15
Whole Fish (0.5 kg)	100	10 - 15	5 - 10
Fish fillets (0.5 kg)	100	12 - 15	5 - 10
Butter (0.25 kg)	100	4 - 6	5 - 10
Grated cheese (0.2 kg)	100	2 - 4	10 - 15
Yeast cake (1 piece)	200	2 - 3	15 - 20
Cheesecake (1 piece)	100	2 - 4	15 - 20
Dry cake (e.g. Pound cake) (1 piece)	200	2 - 4	15 - 20
Bread (1 kg)	200	15 - 18	5 - 10
Sliced bread (0.2 kg)	200	3 - 5	5 - 10
Bread rolls (4 pieces)	200	2 - 4	2 - 5
Fruit (0.25 kg)	100	5 - 10	10 - 15

Reheating

Food	Power (Watts)	Time (min)	Standing time (min)
Baby food in jars (0.2 kg); stir and check the temperature	300	1 - 2	-
Baby milk (180 ml); put the spoon into the bottle, stir and check the temperature	600	0:20 - 0:40	-
Convenience food (0.5 kg)	600	6 - 9	2 - 5
Frozen ready meals (0.5 kg)	400	10 - 15	2 - 5
Milk (200 ml)	1000	1 - 1:30	-
Water (200 ml)	1000	1:30 - 2	-
Sauce (200 ml)	600	1 - 3	-
Soup (300 ml)	600	3 - 5	-

Melting

Food	Power (Watts)	Time (min)	Standing time (min)
Chocolate / Chocolate coating (0.15 kg)	300	2 - 4	-
Butter (0.1 kg)	400	0:30 - 1:30	-

Microwave cooking

Cooking

Food	Power (Watts)	Time (min)	Standing time (min)
Whole fish (0.5 kg)	500	8 - 10	2 - 5
Fish fillets (0.5 kg)	400	4 - 7	2 - 5
Vegetables, fresh (0.5 kg + 50 ml of water)	600	5 - 15	-
Vegetables, frozen (0.5 kg + 50 ml of water)	600	10 - 20	-
Jacked potatoes (0.5 kg)	600	7 - 10	-

Food	Power (Watts)	Time (min)	Standing time (min)
Rice (0.2 kg + 400 ml of water)	600	15 - 18	-
Popcorn	1000	1:30 - 3	-

Microwave Combi function

Use this function to cook food in a shorter time and to brown it.

Food	Function	Power (Watts)	Temperature (°C)	Time (min)	Shelf position	Comments
Potato Gratin (1.1 kg)	Grilling + MW	400	180 - 190	40 - 45	1	Turn the container around halfway through the cooking time. Standing time: 2 - 5min.
Cake (0.7 kg)	Conventional (Top and Bottom Heat) + MW	100	180 - 200	25 - 30	2	Turn the container around halfway through the cooking time. Standing time: 5min.
Lasagne	Conventional (Top and Bottom Heat) + MW	200 - 300	170 - 190	30 - 40	1	Turn the container around halfway through the cooking time. Standing time: 2 - 5min.
Chicken (1 kg)	Grilling + MW	400	210 - 230	35 - 40	2	Turn the container around halfway through the cooking time. Standing time: 2 - 5min.









Tips for the Microwave

Cooking/Defrosting results	Possible cause	Remedy
The food is too dry.	The power was too high. The time was too long.	Next time select a lower microwave power and a longer time.

Cooking/Defrosting results	Possible cause	Remedy
The food is still not defrosted, hot or cooked after the end of cooking time.	The time was too short.	Set a longer time. Do not increase the microwave power.
The food is overheated at the edges but is still not ready in the middle.	The power was too high.	Next time select a lower microwave power and a longer time.

Cooking table

Use the first shelf position.

Quantity (kg)	Food	Function	Temperature (°C)	Time (min)
1	Roast veal		210 - 220	90 - 120
0.4 - 0.5 each	Chicken half		210 - 230	35 - 50
1.5 - 2	Duck		190 - 210	80 - 100
1 - 1.5	Whole fish		210 - 220	40 - 70
-	Stuffed vegetables		160 - 170	30 - 60
-	Sponge cake		140 - 150	35 - 50
-	Short pastry biscuits		150 - 160	10 - 20
-	Pizza (thin crust) ¹⁾		200 - 230	15 - 25
-	Bread (rye bread) ¹⁾		first: 230 then: 160 - 180	first: 20 then: 30 - 60

1) Preheat the oven.

Examples of cooking applications for power settings

The data in the table is for guidance only.

Power setting	Use
<ul style="list-style-type: none"> • 1000 Watt • 900 Watt • 800 Watt • 700 Watt 	Heating liquids Searing at the start of the cooking process Cooking vegetables
<ul style="list-style-type: none"> • 600 Watt • 500 Watt 	Defrosting and heating frozen meals Heating one-plate meals Simmering stews Cooking egg dishes
<ul style="list-style-type: none"> • 400 Watt • 300 Watt 	Continuing to cook meals Cooking delicate food Heating baby food Simmering rice Heating delicate food Melting cheese, chocolate, butter
<ul style="list-style-type: none"> • 200 Watt • 100 Watt 	Defrosting meat, fish Defrosting cheese, cream, butter Defrosting fruit and cakes Defrosting bread

Information for test institutes

Microwave function

Tests according to IEC 60705.

Food	Power (Watts)	Quantity (kg)	Shelf position 1)	Time (min)	Comments
Sponge cake	600	0.475	Bottom	7 - 9	Turn container around by 1/4, halfway through the cooking time.
Meatloaf	400	0.9	2	25 - 32	Turn container around by 1/4, halfway through the cooking time.
Egg custard	500	1	Bottom	18	-
Meat defrosting	200	0.5	Bottom	8 - 12	Turn the meat upside down halfway through the cooking time.

1) Use wire shelf unless otherwise specified.

Microwave Combi function

Tests according to IEC 60705.

Food	Function	Power (Watts)	Temperature (°C)	Shelf position 1)	Time (min)	Comments
Cake (0.7 kg)	True Fan Cooking + MW	100	180	2	29 - 31	Turn container around by 1/4, halfway through the cooking time.
Potato gratin (1.1 kg)	Grill + MW	400	160	1	40 - 45	Turn container around by 1/4, halfway through the cooking time.
Chicken (1.1 kg)	Grill + MW	400	230	1	45 - 55	Put the meat in round glass container and turn it upside down after 20 minutes of the cooking time.

1) Use wire shelf unless otherwise specified.

Care and cleaning

 **Warning!** Refer to Safety chapters.

Notes on cleaning

Cleaning Agents

Clean the front of the oven with a soft cloth with warm water and a mild cleaning agent.

To clean metal surfaces, use a dedicated cleaning agent.

Clean stubborn stains with a special oven cleaner.

Everyday Use

Clean the oven cavity after each use. Fat accumulation or other food remains may cause fire.

Dry the cavity with a soft cloth after each use.

Clean the cavity ceiling carefully from food residuals and fat.

Accessories

Clean all accessories after each use and let them dry. Use a soft cloth with warm water and a cleaning agent. Do not clean the accessories in the dishwasher.

Do not clean the non-stick accessories using aggressive agents, sharp-edged objects or in a dishwasher

Stainless steel or aluminium ovens

Clean the oven door with a damp cloth or sponge only. Dry it with a soft cloth.

Do not use steel wool, acids or abrasive materials as they can damage the oven surface. Clean the oven control panel with the same precautions.

Cleaning the door gasket

Regularly do a check of the door gasket. The door gasket is around the frame of the oven cavity. Do not use the oven if the door gasket is damaged. Contact an Authorised Service Centre.

To clean the door gasket, refer to the general information about cleaning.

Removing the shelf supports

Before maintenance, make sure that the oven is cool. There is a risk of burns.

To clean the oven, remove the shelf supports.

1. Pull carefully the supports up and out of the front catch.

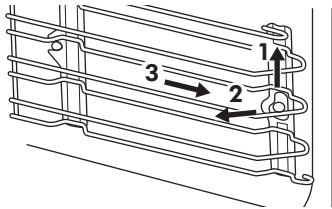

2. Pull the front end of the shelf support away from the side wall.
3. Pull the supports out of the rear catch. Install the shelf supports in the opposite sequence.

Replacing the lamp

Put a cloth on the bottom of the interior of the oven. It prevents damage to the lamp glass cover and the cavity.

Warning! Danger of electrocution! Disconnect the fuse before you replace the lamp. The lamp and the lamp glass cover can be hot.

Caution! Always hold the halogen lamp with a cloth to prevent grease residue from burning on the lamp.

1. Turn off the oven.
2. Remove the fuses from the fuse box or turn off the circuit breaker.
3. Turn the lamp glass cover counterclockwise to remove it.
4. Clean the glass cover.
5. Replace the oven light bulb with a 25 W, 230 V (50 Hz), 300 °C heat resistant oven light bulb (connection type: G9).
6. Install the glass cover.

Troubleshooting

Warning! Refer to Safety chapters.

What to do if...

Problem	Possible cause	Remedy
The oven does not heat up.	The oven is deactivated.	Activate the oven.
The oven does not heat up.	The clock is not set.	Set the clock.
The oven does not heat up.	The necessary settings are not set.	Make sure that the settings are correct.
The oven does not heat up.	The automatic switch-off is activated.	Refer to "Automatic switch-off".

Problem	Possible cause	Remedy
The oven does not heat up.	The Child Lock is on.	Refer to "Using the Child Lock".
The oven does not heat up.	The fuse is blown.	Make sure that the fuse is the cause of the malfunction. If the fuse is blown again and again, contact a qualified electrician.
The lamp does not operate.	The lamp is defective.	Replace the lamp.
Steam and condensation settle on the food and in the cavity of the oven.	You left the dish in the oven for too long.	Do not leave the dishes in the oven for longer than 15 - 20 minutes after the cooking process ends.
The display shows ---°C.	You want to set the microwave function but the door is open or the microwave function set with 0 Watt.	Close the door if they are still open, go back to the off position and set the microwave function again.
The display shows an error code that is not in this table.	There is an electrical fault.	<ul style="list-style-type: none"> Deactivate the oven with the house fuse or the safety switch in the fuse box and activate it again. If the display shows the error code again, contact an Authorised Service Centre.

Service data

If you cannot find a solution to the problem yourself, contact an Authorised Service Centre.

The necessary data for the service centre is on the rating plate. The rating plate is on the front frame of the oven cavity. Do not remove the rating plate from the oven cavity.



We recommend that you write the data here:	
Model (MOD.)
Product number (PNC)
Serial number (S.N.)

Technical data

Technical data

Dimensions (internal)	Width Height Depth	480 mm 217 mm 411 mm
Usable volumes	43 l	
Area of baking tray	1424 cm ²	
Top heating element	1900 W	
Bottom heating element	1000 W	
Grill	1900 W	
Ring	1650 W	
Total rating	3000 W	
Voltage	220 - 240 V	
Frequency	50 Hz	
Number of functions	10	

Environmental concerns

Recycle materials with the symbol . Put the packaging in relevant containers to recycle it. Help protect the environment and human health by recycling waste of electrical and electronic appliances. Do not dispose of appliances marked with the symbol  with the household waste. Return the product to your local recycling facility or contact your municipal office.

EN Parts Name	Hazardous substances					
	Pb	Hg	Cd	Cr6+	PBBs	PBDEs
Cabinet	○	○	○	○	○	○
Cavity (including lamp, sensor, heaters, insulation, hot air motor & fan, lateral grids, magnetron only for microwaves)	✕	○	○	○	○	○
Fan motor & Cooling system	✕	○	○	○	○	○
Door (including wavechoke lamella for microwaves)	○	○	○	○	○	○
Control Panel	✕	○	○	○	○	○
Wiring	✕	○	○	○	○	○
Accessories (cooking tools as meat probe, shelves, baking tray)	✕	○	○	○	○	○
Fittings for installation (screws)	○	○	○	○	○	○

Note:

1. "Exceeding 0.1 wt%" and "Exceeding 0.01 wt%" indicate that percentage content of the restricted substance exceeds the reference percentage value of presence condition.
2. ○ indicates that the percentage content of the restricted substance does not exceed the percentage of reference value of presence.
3. ✕ indicates that the restricted substance correspond to the exemption.

IKEA GUARANTEE

How long is the IKEA guarantee valid?

This guarantee is valid for five (5) years from the original date of purchase of your appliance at IKEA. The original sales receipt is required as proof of purchase. If service work is carried out under guarantee, this will not extend the guarantee period for the appliance.

Who will execute the service?

IKEA service provider will provide the service through its own service operations or authorized service partner network.

What does this guarantee cover?

The guarantee covers faults of the appliance, which have been caused by faulty construction or material faults from the date of purchase from IKEA. This guarantee applies to domestic use only. The exceptions are specified under the headline "What is not covered under this guarantee?" Within the guarantee period, the costs to remedy the fault e.g. repairs, parts, labour and travel will be covered, provided that the appliance is accessible for repair without special expenditure. On these conditions the respective local regulations are applicable. Replaced parts become the property of IKEA.

What will IKEA do to correct the problem?

IKEA appointed Service Provider will examine the product and decide, at its sole discretion, if it is covered under this guarantee. If considered covered, IKEA Service Provider or its authorized service partner through its own service operations, will then, at its sole discretion, either repair the defective product or replace it with the same or a comparable product.

What is not covered under this guarantee?

- Normal wear and tear.
- Deliberate or negligent damage, damage caused by failure to observe operating instructions, incorrect installation or by connection to the wrong voltage, damage caused by chemical or electro-chemical reaction, rust, corrosion or water damage including but not limited to damage caused by excessive lime in the water supply, damage caused by abnormal environmental conditions.
- Consumable parts including batteries and lamps.
- Non-functional and decorative parts which do not affect normal use of the appliance, including any scratches and possible color differences.
- Accidental damage caused by foreign objects or substances and cleaning or unblocking of filters, drainage systems or soap drawers.
- Damage to the following parts: ceramic glass, accessories, crockery and cutlery baskets, feed and drainage pipes, seals, lamps and lamp covers, screens, knobs, casings and parts of casings. Unless such damages can be proved to have been caused by production faults.
- Cases where no fault could be found during a technician's visit.
- Repairs not carried out by our appointed service providers and/or an authorized service contractual partner or where non-original parts have been used.
- Repairs caused by installation which is faulty or not according to specification.
- The use of the appliance in a non-domestic environment i.e. professional use.
- Transportation damages. If a customer transports the product to his home or another address, IKEA is not liable for any damage that may occur during transport. However, if IKEA delivers the product to the customer's delivery address, then damage to the product that occurs during this delivery will be covered by IKEA.
- Cost for carrying out the initial installation of the IKEA appliance.
- However, if an IKEA appointed Service Provider or its authorized service partner

repairs or replaces the appliance under the terms of this guarantee, the appointed Service Provider or its authorized service partner will reinstall the repaired appliance or install the replacement, if necessary.

- All plumbing and electrical installation, are not the responsibility of IKEA, and customer must complete these work before the execution work.

How country law applies

The IKEA guarantee gives you specific legal rights, which cover or exceed all the local legal demands. However these conditions do not limit in any way consumer rights described in the local legislation.

Area of validity

This warranty is valid only in the country where the product has been purchased; the services will be provided in the framework of the guarantee conditions. An obligation to carry out services in the framework of the guarantee exists only if the appliance complies and is installed in accordance with:

- the technical specifications of the country in which the guarantee claim is made;
- the Assembly Instructions and User Manual Safety Information;

The dedicated AFTER SALES for IKEA appliances

Please don't hesitate to contact IKEA appointed Authorized Service Centre to:

- make a service request under this guarantee;
- ask for clarifications on installation of the IKEA appliance in the dedicated IKEA kitchen furniture;
- ask for clarification on functions of IKEA appliances.

To ensure that we provide you with the best assistance, please read carefully the Assembly Instructions and/or the User Manual before contacting us.

How to reach us if you need our service



i The IKEA after sales customer service center will assist you on the phone with basic troubleshooting for your appliances at the time of service call request. Please refer to **www.IKEA.com** and select your local store for local store phone numbers and opening times.

i Before calling us, assure that You have to hand the IKEA article number (8 digit code) and the Serial Number (8 digit code that can be found on the rating plate) for the appliance of which you need our assistance.

i **SAVE THE SALES RECEIPT!** It is your proof of purchase and required for the guarantee to apply. Note that the receipt reports also the IKEA article name and number (8 digit code) for each of the appliances you have purchased.

Do you need extra help?

For any additional questions not related to After Sales of your appliances please contact your nearest IKEA store call centre. We recommend you read the appliance documentation carefully before contacting us.

86736248-A-112021



© Inter IKEA Systems B.V. 2021

21552

AA-2283042-1