

GRUNDAD



Design and Quality
IKEA of Sweden



ENGLISH

For the IKEA appointed Authorized Service Centre, please refer to www.IKEA.com and select your local store for phone numbers and opening times.

ENGLISH

4

Contents

Safety information	4	Care and cleaning	16
Safety instructions	6	Troubleshooting	16
Installation	8	Technical data	18
Electrical connection	9	Energy saving	18
Product description	11	Environmental concerns	19
Daily use	12	IKEA GUARANTEE	21
Cooking table	14		
Cookware guidance	15		

Subject to change without notice.

Safety information

Before the installation and use of the appliance, carefully read the supplied instructions. The manufacturer is not responsible if an incorrect installation and use causes injuries and damage. Always keep the instructions with the appliance for future reference.

Children and vulnerable people safety

- This appliance is not intended for use by persons (including children) with reduced physical, sensory or mental capabilities, or lack of experience and knowledge, unless they have been given supervision or instruction concerning use of the appliance by a person responsible for their safety.
- Children should be supervised to ensure that they do not play with the appliance.
- Keep all packaging away from children and dispose of it appropriately.
- **WARNING:** Keep children and pets away from the appliance when it operates or when it cools down. Accessible parts become hot during use.
- If the appliance has a child safety device, it should be activated.

- Children shall not carry out cleaning and user maintenance of the appliance without supervision.

General Safety

- **WARNING:** The appliance and its accessible parts become hot during use. Care should be taken to avoid touching heating elements.
- Do not operate the appliance by means of an external timer or separate remote-control system.
- **WARNING:** Unattended cooking on a hob with fat or oil can be dangerous and may result in fire.
- **NEVER** try to extinguish a fire with water, but switch off the appliance and then cover flame e.g. with a lid or a fire blanket.
- **CAUTION:** The cooking process has to be supervised. A short term cooking process has to be supervised continuously.
- **WARNING:** Danger of fire: Do not store items on the cooking surfaces.
- Metallic objects such as knives, forks, spoons and lids should not be placed on the hob surface since they can get hot.
- Do not use the appliance before installing it in the built-in structure.
- Disconnect the appliance from the electrical supply before maintenance.
- Do not use a steam cleaner to clean the appliance.
- After use, switch off the hob element by its control and do not rely on the pan detector.
- If the glass ceramic surface / glass surface is cracked, switch off the appliance and unplug it from the mains. In case the appliance is connected to the mains directly using junction box, remove the fuse to disconnect the appliance from power supply. In either case contact the Authorised Service Centre.

- If the supply cord is damaged, it must be replaced by the manufacturer, the Authorised Service Centre or similarly qualified persons in order to avoid a hazard.
- **WARNING:** Use only hob guards designed by the manufacturer of the cooking appliance or indicated by the manufacturer of the appliance in the instructions for use as suitable or hob guards incorporated in the appliance. The use of inappropriate guards can cause accidents.

Safety instructions

Installation

 **Warning!** The appliance must be installed by the authorised installer.

 Follow the Assembly instructions supplied with the appliance.

- Remove all the packaging.
- Do not install or use a damaged appliance.
- Keep the minimum distance from other appliances and units.
- Always take care when moving the appliance as it is heavy. Always use safety gloves and enclosed footwear.
- Seal the cut surfaces with a sealant to prevent moisture from causing swelling.
- Protect the bottom of the appliance from steam and moisture.
- Do not install the appliance next to a door or under a window. This prevents hot cookware from falling from the appliance when the door or the window is opened.
- Make sure that the space underneath the hob is sufficient for air circulation.
- The bottom of the appliance can get hot. If the appliance is installed above the drawers, make sure to install a non-combustible separation panel under the appliances to prevent access to the bottom.

Electrical Connection

 **Warning!** Risk of fire and electric shock.

- All electrical connections should be made by the authorised installer.
- The appliance must be earthed.
- Before carrying out any operation make sure that the appliance is disconnected from the power supply.
- Make sure that the parameters on the rating plate are compatible with the electrical ratings of the mains power supply.
- Make sure the appliance is installed correctly. Loose and incorrect electricity mains cable or plug (if applicable) can make the terminal become too hot.
- Use the correct electricity mains cable.
- Do not let the electricity mains cable tangle.
- Make sure that a shock protection is installed.
- Use the strain relief clamp on the cable.
- Make sure the mains cable or plug (if applicable) does not touch the hot appliance or hot cookware, when you connect the appliance to the near sockets.
- Do not use multi-plug adapters and extension cables.
- Make sure not to cause damage to the mains plug (if applicable) or to the mains cable. Contact our Authorised Service

Centre or an electrician to change a damaged mains cable.

- The shock protection of live and insulated parts must be fastened in such a way that it cannot be removed without tools.
- Connect the mains plug to the mains socket only at the end of the installation. Make sure that there is access to the mains plug after the installation.
- If the mains socket is loose, do not connect the mains plug.
- Do not pull the mains cable to disconnect the appliance. Always pull the mains plug.
- Use only correct isolation devices: line protecting cut-outs, fuses (screw type fuses removed from the holder), earth leakage trips and contactors.
- Please use the exclusive overcurrent protection circuit breaker with a contact of 3 mm or more certified by BSMI, and put it in a place where the user can operate it.

Use

 **Warning!** Risk of injury, burns and electric shock.

- Remove all the packaging, labelling and protective film (if applicable) before first use.
- This appliance is for household (indoors) use only.
- Do not change the specification of this appliance.
- Make sure that the ventilation openings are not blocked.
- Do not let the appliance stay unattended during operation.
- Set the cooking zone to "off" after each use.
- Do not rely on the pan detector.
- Do not put cutlery or saucepan lids on the cooking zones. They can become hot.
- Do not operate the appliance with wet hands or when it has contact with water.
- Do not use the appliance as a work surface or as a storage surface.
- If the surface of the appliance is cracked, disconnect immediately the appliance

from the power supply. This to prevent an electrical shock.

- Users with a pacemaker must keep a distance of minimum 30 cm from the induction cooking zones when the appliance is in operation.
- When you place food into hot oil, it may splash.

 **Warning!** Risk of fire and explosion

- Fats and oil when heated can release flammable vapours. Keep flames or heated objects away from fats and oils when you cook with them.
- The vapours that very hot oil releases can cause spontaneous combustion.
- Used oil, that can contain food remnants, can cause fire at a lower temperature than oil used for the first time.
- Do not put flammable products or items that are wet with flammable products in, near or on the appliance.

 **Warning!** Risk of damage to the appliance.

- Do not keep hot cookware on the control panel.
- Do not put a hot pan cover on the glass surface of the hob.
- Do not let cookware boil dry.
- Be careful not to let objects or cookware fall on the appliance. The surface can be damaged.
- Do not activate the cooking zones with empty cookware or without cookware.
- Do not put aluminium foil on the appliance.
- Cookware made of cast iron, aluminium or with a damaged bottom can cause scratches on the glass / glass ceramic. Always lift these objects up when you have to move them on the cooking surface.
- This appliance is for cooking purposes only. It must not be used for other purposes, for example room heating.

Care and cleaning

- Clean the appliance regularly to prevent the deterioration of the surface material.
- Switch off the appliance and let it cool down before cleaning.
- Do not use water spray and steam to clean the appliance.
- Clean the appliance with a moist soft cloth. Use only neutral detergents. Do not use abrasive products, abrasive cleaning pads, solvents or metal objects.

Service

- To repair the appliance contact the Authorised Service Centre. Use original spare parts only.
- Concerning the lamp(s) inside this product and spare part lamps sold separately: These lamps are intended to

withstand extreme physical conditions in household appliances, such as temperature, vibration, humidity, or are intended to signal information about the operational status of the appliance. They are not intended to be used in other applications and are not suitable for household room illumination.

Disposal

Warning! Risk of injury or suffocation.

- Contact your municipal authority for information on how to discard the appliance correctly.
- Disconnect the appliance from the mains supply.
- Cut off the mains electrical cable close to the appliance and dispose of it.

Installation

Warning! Refer to Safety chapters.

General information

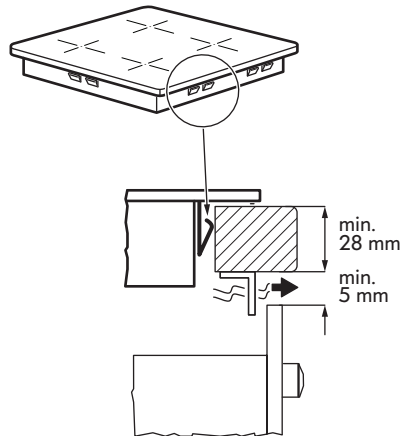
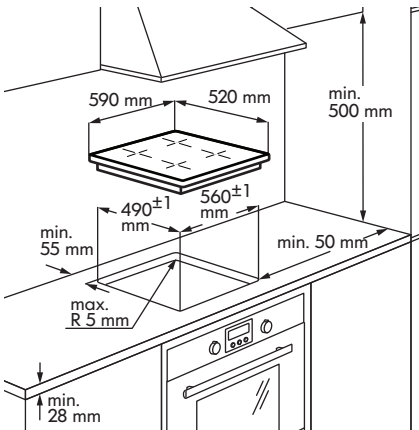

-  Installation process must follow the laws, ordinances, directives and standards (electrical safety rules and regulations, proper recycling in accordance with the regulations, etc.) in force in the country of use!
- For further information on the installation refer to the Assembly Instruction.

- If there is no oven beneath the hob, install a separation panel under the appliance according to the Assembly Instruction.
- Do not use silicon sealant between the appliance and the worktop.

Electrical connection

 **Warning!** Refer to Safety chapters.

 **Warning!** All electrical connections must be made by an authorised installer.

Electrical connection

- Before connecting, check if the nominal voltage of the appliance, provided on the rating plate, corresponds to the available supply voltage. The rating plate is located on the lower casing of the hob.
- Follow the connection diagram (it is located on the underneath surface of the casing of the hob).
- Use only original spare parts provided by spare parts service.
- The appliance is not provided with a mains cable. Buy the right one from a specialized dealer. Single phase or two-phase connection requires a mains cable of minimum 70°C temperature stability. Cable needs mandatory end sleeves. According to IEC regulations use for one-phase connection: mains cable 3 x 4mm² and for two-phase connection: mains cable 4 x 2.5mm². Please respect specific national regulations in the first priority.
- You must have the means for disconnection incorporated in the fixed wiring.
- You must have the connection and the connecting links carried out as shown in the connection diagram.
- The earth lead is connected to terminal and must be longer than leads carrying electric current.
- Secure the connecting cable with cable clips or clamps.

Connection diagram

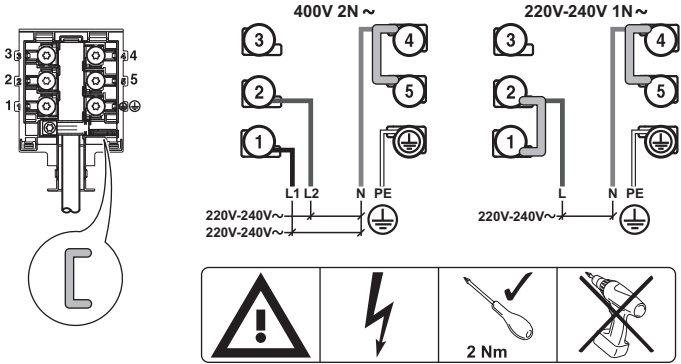

i Insert the shunts  between the screws as shown.

Main power connection 1-phase

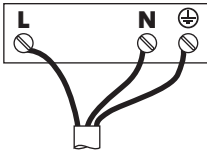

Wiring colours:
 ⊕ Yellow / green
 N Blue
 L Black or brown

Main power connection 2-phase

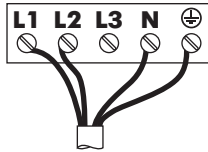

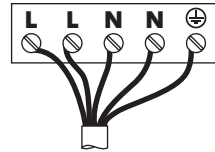

Wiring colours:
 ⊕ Yellow / green
 N Blue
 L1 Black
 L2 Brown

NL Main power connection 2-phase



Wiring colours:
 ⊕ Yellow / green
 N Blue
 N Blue
 L Black
 L Brown

i Tighten the terminal screws securely!

i If  or  symbol comes on the display after you switch on the hob for the first time, refer to "Troubleshooting".

Once you connect the hob to the mains, check if all the cooking zones are ready to use. Place a pot with some water on a cooking zone and set the power setting for each zone to the maximum level for a short time.

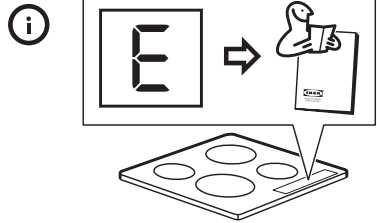
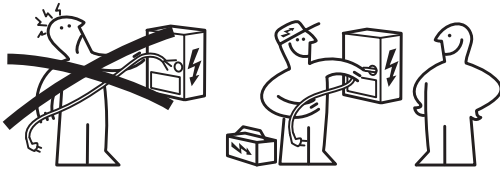

Product description

Cooking surface layout

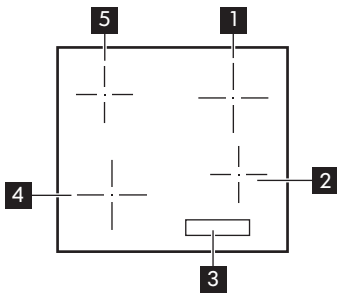

- 1 Single cooking zone (180 mm) 1800 W
- 2 Single cooking zone (145 mm) 1200 W
- 3 Control panel
- 4 Single cooking zone (180 mm) 1800 W
- 5 Single cooking zone (145 mm) 1200 W

Control panel layout

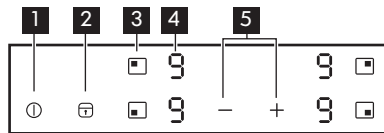

- 1 To switch the hob on or off.
- 2 To activate and deactivate Lock / Child Lock / Cleaning mode.
- 3 To select the cooking zone.
- 4 Power setting display: .
- 5 To increase or decrease the heat settings.

Power setting displays

Display	Description
	The cooking zone is deactivated.
	The cooking zone operates.
+ digit	There is a malfunction. Refer to "Troubleshooting".
	A cooking zone is still hot (residual heat).
	Lock / Child Lock / Cleaning mode operates.
	Incorrect or too small cookware or no cookware on the cooking zone.
	Automatic Switch Off operates.

Residual heat indicator

Warning! There is a risk of burns from residual heat.

The indicators show the level of the residual heat for the cooking zones you are currently using. The indicators may also come on for

the neighbouring cooking zones even if you are not using them.

The induction cooking zones produce the heat necessary for the cooking process directly in the bottom of the cookware. The glass ceramic is heated by the heat of the cookware.

Daily use

① Switching on / off

Touch for 1 second to switch the appliance on / off.

Automatic Switch Off

The function switches off the appliance automatically if:



- all cooking zones are deactivated.
- you do not set the power setting after switching on the appliance.
- you cover any symbol with an object (a pan, a cloth, etc.) for longer than approx. 10 seconds.
- you do not deactivate a cooking zone after a certain time, or you do not modify the power setting, or if overheating occurs (e.g. when a pan boils dry). The

symbol lights up. Before using again, you must set the cooking zone to .

Power setting	Automatic switch off after
	6 hours
	5 hours
	4 hours
	1.5 hours



If cookware that is not suitable is used, lights up on the display and after 2 minutes the indicator for the cooking zone deactivates.

Adjusting the power setting

To set the cooking zone touch the sensor field  related to this zone. The display highlights the heat setting indication (.

Touch  to increase the heat setting.

Touch  to decrease the heat setting.



Touch  and  at the same time to deactivate the cooking zone.

Lock / Cleaning mode

You can lock the control panel and keep the cooking zones operating. It prevents an accidental change of the power setting.

-  Use the function to clean the surface of the hob during the cooking session, if needed.

First set the power setting.

To start the function touch . The symbol  comes on for 4 seconds.





To stop the function touch . The power setting that you set before comes on.

When you switch off the appliance, you also stop this function.





Child Lock

This function prevents an accidental operation of the appliance.





To activate the function:

- Switch on the appliance with . Do not set the power settings.
- Touch  for 4 seconds. The symbol  comes on.
- Switch off the appliance with .

To deactivate the function:

- Switch on the appliance with . Do not set the power settings. Touch  for 4 seconds. The symbol  comes on.
- Switch off the appliance with .









To override the function for only one cooking time:

- Switch on the appliance with . The symbol  comes on.
- Touch  for 4 seconds. Set the power setting in 10 seconds. You can operate the appliance.
- When you switch off the appliance with , the function operates again.

OffSound Control (Deactivation and activation of the sounds)

Originally the sounds of the appliance are activated.

Activating and deactivating the sounds:

1. Switch off the appliance.
2. Touch  for 3 seconds. The display comes on and goes out.
3. Touch  for 3 seconds. On the left front zone display  comes on and on the right front zone display  or  comes on.
4. Touch  of the rear right zone to choose one of the following:
 -  on the right front zone display - the sounds are off.
 -  on the right front zone display - the sounds are on.

To confirm your selection wait for 10 seconds until the appliance switches off automatically.

When the function is set to  you can hear the sounds only when:

- you touch .
- you put something on the control panel.

-  If there is a problem with electrical supply and the appliance switches off it does not keep previous settings.

Power exchange function

If multiple zones are active and the consumed power exceeds the limitation of the power supply, this function divides the available power between all cooking zones. The hob controls heat settings to protect the fuses of the house installation.

- Cooking zones are grouped according to the location and number of the phases in the hob. Each phase has a maximum electricity loading. If the hob reaches the limit of maximum available power within one phase, the power of the cooking zones will be automatically reduced.
- The heat setting of the cooking zone selected last is always prioritised. The remaining power will be divided between the previously activated cooking zones in reverse order of selection.
- The heat setting display of the reduced zones changes between the initially selected heat setting and the reduced heat setting.

- Wait until the display stops flashing or reduce the heat setting of the cooking zone selected last. The cooking zones will continue operating with the reduced heat setting. Change the heat settings of the cooking zones manually, if necessary. Refer to the illustration for possible combinations in which power can be distributed among the cooking zones.

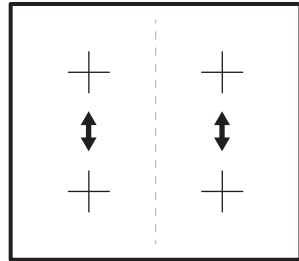

Cooking table

Heat setting	Use to:	Time (min)	Hints
1	Keep cooked food warm.	as necessary	Put a lid on the cookware.
1 - 2	Hollandaise sauce, melt: butter, chocolate, gelatine.	5 - 25	Mix from time to time.
1 - 2	Solidify: fluffy omelettes, baked eggs.	10 - 40	Cook with a lid on.
2 - 3	Simmer rice and milkbased dishes, heat up ready-cooked meals.	25 - 50	Add at least twice as much liquid as rice, mix milk dishes halfway through the procedure.
3 - 4	Steam vegetables, fish, meat.	20 - 45	Add a couple of tablespoons of liquid.

Heat setting	Use to:	Time (min)	Hints
4 - 5	Steam potatoes.	20 - 60	Use max. ¼ l of water for 750 g of potatoes.
4 - 5	Cook larger quantities of food, stews and soups.	60 - 150	Up to 3 l of liquid plus ingredients.
6 - 7	Gentle fry: escalope, veal cordon bleu, cutlets, rissoles, sausages, liver, roux, eggs, pancakes, doughnuts.	as necessary	Turn halfway through.
7 - 8	Heavy fry, hash browns, loin steaks, steaks.	5 - 15	Turn halfway through.
9	Boil water, cook pasta, sear meat (goulash, pot roast), deep-fry chips.		

 The data in the table is for guidance only.

Cookware guidance

 **Warning!** Refer to Safety chapters.

What pots to use

Only use cookware which is suitable for induction hobs. The cookware must be made of a ferromagnetic material, such as:

- cast iron;
- enamelled steel;
- carbon steel;
- stainless steel (most types);
- aluminium with ferromagnetic coating or a ferromagnetic plate.

To determine if a pot or pan is suitable, check for the symbol  (usually stamped on the bottom of the cookware). You can also hold a magnet to the bottom. If it clings to the underside, the cookware will work on the induction hob.

To ensure optimum efficiency, always use pots and pans with a flat bottom that distributes the heat evenly. If the bottom is uneven, this will affect power and heat conduction.

How to use

Minimum diameter of pot / pan base for the different cooking areas

To ensure that the hob operates properly, the cookware must have a suitable minimum diameter as well as cover one or more of the reference points indicated on the surface of the hob.

Always use the cooking zone that best corresponds to the diameter of the bottom of the cookware.

Cooking zone	Cookware diameter [mm]
Left rear	125 - 145
Left front	145 - 180
Right rear	145 - 180
Right front	125 - 145

Empty or thin-based pots / pans

Do not use empty pots / pans or cookware with thin bases on the hob as it will not be able to monitor the temperature, or will turn off automatically if the temperature is too high. This may result in the damage of the cookware or the hob surface. If such a situation occurs, do not touch anything and wait for all components to cool down.

If an error message appears, refer to "Troubleshooting".





Hints / tips

Noises during cooking

When a cooking zone is active, it may hum briefly. This is characteristic of all ceramic glass cooking zones and does not impair either the function or the life of the appliance. The noise depends on the cookware used. If it causes considerable disturbance, it might help to change the cookware.

Care and cleaning

General information

-  **Warning!** Switch off the appliance and let it cool down before you clean it.
-  **Warning!** For safety reasons, do not clean the appliance with steam blasters or high-pressure cleaners.
-  **Warning!** Sharp objects and abrasive cleaning agents will damage the appliance. Clean the appliance and remove the residues with water and dish soap after each use. Remove also the remnants of the cleaning agents.
-  Scratches or dark stains on the glass ceramic that cannot be removed do not affect the functioning of the appliance.

Removing the residues and stubborn residues



Food containing sugar, plastics, or tin foil residues should be removed at once. A scraper is the best tool for cleaning the glass surface. It is not supplied with the appliance. Place a scraper on the hob surface at an angle and remove residues by sliding the blade over the surface. Clean the appliance using a damp cloth and some dish soap. Finally, wipe the glass surface dry with a clean cloth.

Limescale rings, water rings, fat splashes, or shiny metallic discolourations should be removed after the appliance has cooled down. Use only a specialised cleaner for glass ceramic or stainless steel.

Troubleshooting

-  **Warning!** Refer to Safety chapters.

What to do if...

Problem	Possible cause	Remedy
You cannot switch on the appliance or operate it.	The hob is not connected to an electrical supply or it is connected incorrectly.	Check if the hob is correctly connected to the electrical supply. Refer to the connection diagram.
	The fuse is blown.	Make sure that the fuse is the cause of the malfunction. If the fuse is blown again and again, contact an authorised installer.
	You did not set the power setting in less than 10 seconds.	Switch on the hob again and set the power setting in less than 10 seconds.
	You touched 2 or more symbols at the same time.	Touch only one symbol at a time.
	There is water or fat stains on the control panel.	Clean the control panel and wait for a few seconds before activating again.
An acoustic signal sounds and the hob switches off. An acoustic signal sounds when the hob is switched off.	You put something on one or more symbols on the control panel.	Remove the object from the symbols.
The appliance switches off.	You put something on the symbol  .	Remove the object from the symbols.
Residual heat indicator does not come on.	The zone is not hot because it operated only for a short time.	If the zone operated sufficiently long to be hot, speak to the After Sales Service.
The power setting changes between two levels.	Power exchange function operates.	Refer to "Daily use".
The symbols become hot.	The cookware is too large or you put it too near to the controls.	Put large cookware on the rear zones, if possible.
There is no signal when you touch a symbol on the control panel.	The signals are deactivated.	Activate the signals. Refer to "Daily use" > "Off-Sound Control".
 comes on.	Automatic Switch Off operates.	Switch off the hob and switch it on again.
 comes on.	Child Lock or Lock operates.	Refer to "Daily use".

Problem	Possible cause	Remedy
E and a number come on.	There is an error in the hob.	Disconnect the hob from the electrical supply for some time. Disconnect the fuse from the electrical system of the house. Connect it again. If E comes on again, speak to an authorised installer.
E4 comes on.	There is an error in the hob because a pot boiled dry. Automatic Switch Off and the overheating protection for the zones operate.	Switch off the hob. Remove the hot cookware. After approximately 30 seconds, activate the zone again. If the cookware was the problem, the error message goes out. Residual heat indicator can stay on. Let the cookware become sufficiently cool. Check if your cookware is compatible with the hob. Refer to "Cookware guidance".

If there is a fault, try to resolve it by following the troubleshooting guidelines. If the problem cannot be resolved, contact your IKEA store or the After Sales Service. You can find a full list of IKEA appointed contacts at the end of this user manual.



If you operated the appliance wrongly, or the installation was not carried out by an authorised installer, the visit from the After Sales Service technician or dealer may not take place free of charge, even during the warranty period.

Technical data

Rating Plate

The actual rating plate is located on the bottom of the casing. The serial number is specific to each product.

Dear Customer, keep the additional rating plate with the user manual. This will allow us

to assist you better by identifying precisely your hob, in case you need our assistance in the future. Thank you for your help!

Energy saving

Energy saving

You can save energy during everyday cooking if you follow below hints.

- When you heat up water, use only the amount you need.
- If it is possible, always put the lids on the cookware.

- Before you activate the cooking zone put the cookware on it.
- Put the smaller cookware on the smaller cooking zones.
- Put the cookware directly in the centre of the cooking zone.
- Use the residual heat to keep the food warm or to melt it.

Environmental concerns

Recycle materials with the symbol . Put the packaging in relevant containers to recycle it. Help protect the environment and human health by recycling waste of electrical and electronic appliances. Do not dispose of

appliances marked with the symbol  with the household waste. Return the product to your local recycling facility or contact your municipal office.

<p>設備名稱：電磁爐 Equipment name</p>		<p>型號(型式)：GRUNDAD 304.672.85 Type designation (Type)</p>					
<p>單元 Unit</p>		<p>限用物質及其化學符號 Restricted substances and its chemical symbols</p>					
		鉛 Lead (Pb)	汞 Mercury (Hg)	鎘 Cadmium (Cd)	六價鉻 Hexavalent chromium (Cr+6)	多溴聯苯 Polybrominated biphenyls (PBB)	多溴二苯醚 Polybrominated diphenyl ethers (PBDE)
<p>機械結構 Mechanical Structure</p>	<p>工作臺 (包括玻璃/強化玻璃/不鏽鋼/搪瓷鋼) Working top (including glass ceramic/tempered glass/stainless steel/enamelled steel)</p>	○	○	○	○	○	○
<p>加熱元件 (感應線圈) Heating elements (induction coils)</p>	<p>電子與電子元件 (配電器、使用者介面及其他電子零件) Electric & electronic components (power board, user interface and other electronic parts)</p>	-	○	○	○	○	○
<p>配線與電源線 Wirings & Power cord</p>	<p>配件：組裝指示中所述安裝時所需之其他零件 Fittings: other parts needed for installation as reported in the assembly instruction</p>	-	○	○	○	○	○
<p>備考1. 超出0.1 wt % 及 3 超出0.01 wt % 係指限用物質之百分比含量超出百分比含量基準值。 Note 1: "Exceeding 0.1 wt%" and "Exceeding 0.01 wt%" indicate that percentage content of the restricted substance exceeds the reference percentage value of presence condition. 備考2. 3 係指該項限用物質之百分比含量未超出百分比含量基準值。 Note 2: "○" indicates that the percentage content of the restricted substance does not exceed the percentage of reference value of presence. 備考3. 3 係指該項限用物質為排除項目。 Note 3: ".,." indicate that the restricted substance corresponds to the exemption.</p>		-	○	○	○	○	○

IKEA GUARANTEE

How long is the IKEA guarantee valid?

This guarantee is valid for five (5) years from the original date of purchase of your appliance at IKEA. The original sales receipt is required as proof of purchase. If service work is carried out under guarantee, this will not extend the guarantee period for the appliance.

Who will execute the service?

IKEA service provider will provide the service through its own service operations or authorized service partner network.

What does this guarantee cover?

The guarantee covers faults of the appliance, which have been caused by faulty construction or material faults from the date of purchase from IKEA. This guarantee applies to domestic use only. The exceptions are specified under the headline "What is not covered under this guarantee?" Within the guarantee period, the costs to remedy the fault e.g. repairs, parts, labour and travel will be covered, provided that the appliance is accessible for repair without special expenditure. On these conditions the respective local regulations are applicable. Replaced parts become the property of IKEA.

What will IKEA do to correct the problem?

IKEA appointed Service Provider will examine the product and decide, at its sole discretion, if it is covered under this guarantee. If considered covered, IKEA Service Provider or its authorized service partner through its own service operations, will then, at its sole discretion, either repair the defective product or replace it with the same or a comparable product.

What is not covered under this guarantee?

- Normal wear and tear.
- Deliberate or negligent damage, damage caused by failure to observe operating instructions, incorrect installation or by connection to the wrong voltage, damage caused by chemical or electro-chemical reaction, rust, corrosion or water damage including but not limited to damage caused by excessive lime in the water supply, damage caused by abnormal environmental conditions.
- Consumable parts including batteries and lamps.
- Non-functional and decorative parts which do not affect normal use of the appliance, including any scratches and possible color differences.
- Accidental damage caused by foreign objects or substances and cleaning or unblocking of filters, drainage systems or soap drawers.
- Damage to the following parts: ceramic glass, accessories, crockery and cutlery baskets, feed and drainage pipes, seals, lamps and lamp covers, screens, knobs, casings and parts of casings. Unless such damages can be proved to have been caused by production faults.
- Cases where no fault could be found during a technician's visit.
- Repairs not carried out by our appointed service providers and/or an authorized service contractual partner or where non-original parts have been used.
- Repairs caused by installation which is faulty or not according to specification.
- The use of the appliance in a non-domestic environment i.e. professional use.
- Transportation damages. If a customer transports the product to his home or another address, IKEA is not liable for any damage that may occur during transport. However, if IKEA delivers the product to the customer's delivery address, then damage to the product that occurs during this delivery will be covered by IKEA.
- Cost for carrying out the initial installation of the IKEA appliance.
- However, if an IKEA appointed Service Provider or its authorized service partner

repairs or replaces the appliance under the terms of this guarantee, the appointed Service Provider or its authorized service partner will reinstall the repaired appliance or install the replacement, if necessary.

- All plumbing and electrical installation, are not the responsibility of IKEA, and customer must complete these work before the execution work.

How country law applies

The IKEA guarantee gives you specific legal rights, which cover or exceed all the local legal demands. However these conditions do not limit in any way consumer rights described in the local legislation.

Valid for INDIA only: The courts at New Dehli have exclusive jurisdiction for setting the claims or disputes or matters arising out of present Warranty.

Area of validity

This warranty is valid only in the country where the product has been purchased; the services will be provided in the framework of the guarantee conditions. An obligation to carry out services in the framework of the guarantee exists only if the appliance complies and is installed in accordance with:

- the technical specifications of the country in which the guarantee claim is made;
- the Assembly Instructions and User Manual Safety Information;

The dedicated AFTER SALES for IKEA appliances

Please don't hesitate to contact IKEA appointed Authorized Service Centre to:

- make a service request under this guarantee;
- ask for clarifications on installation of the IKEA appliance in the dedicated IKEA kitchen furniture;
- ask for clarification on functions of IKEA appliances.

To ensure that we provide you with the best assistance, please read carefully the Assembly Instructions and/or the User Manual before contacting us.

How to reach us if you need our service



The IKEA after sales customer service centre will assist you on the phone with basic troubleshooting for your appliances at the time of service call request. Please refer to **www.IKEA.com** and select your local store for local store phone numbers and opening times.



Before calling us, assure that You have to hand the IKEA article number (8 digit code) and the Serial Number (8 digit code that can be found on the rating plate) for the appliance of which you need our assistance.



SAVE THE SALES RECEIPT! It is your proof of purchase and required for the guarantee to apply. Note that the receipt reports also the IKEA article name and number (8 digit code) for each of the appliances you have purchased.

Do you need extra help?

For any additional questions not related to After Sales of your appliances please contact your nearest IKEA store call centre. We recommend you read the appliance documentation carefully before contacting us.

867366551-C-072022

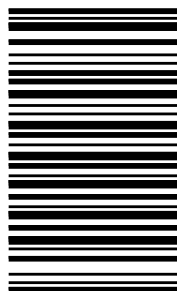

© Inter IKEA Systems B.V. 2022

21552

AA-2282432-3